

**FAG****NN3096-AS-K-M-SP**

## Cylindrical roller bearing

Super precision cylindrical roller bearings  
 NN30..-AS-K-M-SP, non-locating bearing,  
 double row, with tapered bore, taper 1:12,  
 separable, with cage

## Technical information

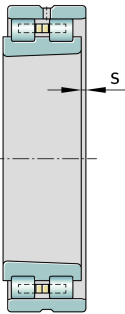

## Your current product variant

Cage	M	Brass Cage
Tolerance class	SP	Tolerance class SP
Bore type	K	Tapered, taper 1:12
Change mark	A	Internal Variant A
Radial internal clearance	C1 (Group 1)	Internal clearance smaller than C2
Number of rows	2	Double-row design

## Main Dimensions &amp; Performance Data

d	480 mm	Bore diameter
D	700 mm	Outside diameter
B	165 mm	Width
$C_r$	2.700.000 N	Basic dynamic load rating, radial
$C_{0r}$	5.800.000 N	Basic static load rating, radial
$C_{ur}$	530.000 N	Fatigue load limit, radial
$n_{G \text{ Grease}}$	1.070 1/min	Limiting speed for grease lubrication
$n_{G \text{ Oil}}$	1.260 1/min	Limiting speed for oil lubrication
$\approx m$	203,4 kg	Weight



### Mounting dimensions

$d_a$	544 mm	Diameter shaft shoulder
	h12	Diameter shaft shoulder tolerance
$D_a$	656 mm	Diameter of housing shoulder
	H12	Shoulder diameter outer ring clearance
$r_{a1 \max}$	5 mm	Maximum recess radius

### Dimensions

$r_{1 \min}$	6 mm	Minimum chamfer dimension
E	644 mm	Raceway diameter outer ring
$n_s$	23,5 mm	Width of lubricating groove
$d_s$	12,5 mm	Diameter lubrication hole
s	11,2 mm	Axial displacement

### Temperature range

$T_{\min}$	-30 °C	Operating temperature min.
$T_{\max}$	150 °C	Operating temperature max.

### Characteristics

	Radial load
	Grease Lubrication
	Oil Lubrication
	Not sealed
	Large bearing