

**SL185056-TB-BR-C3-2S**

Cylindrical roller bearing

Cylindrical roller bearing SL1850..-TB, full complement roller set, two-row, semi-locating bearing, 1 rib on outer ring, 3 ribs on inner ring, type SL18

Technical information



Your current product variant

Design	TB	Bearings with increased axial load capacity
Radial internal clearance	C3 (Group 3)	Internal clearance larger than CN
Tolerance class	PN	Normal (PN)
Number of rows	2	Double-row design

Main Dimensions & Performance Data

d	280 mm	Bore diameter
D	420 mm	Outside diameter
B	190 mm	Width
C_r	2.850.000 N	Basic dynamic load rating, radial
C_{0r}	5.300.000 N	Basic static load rating, radial
C_{ur}	600.000 N	Fatigue load limit, radial
n_G	900 1/min	Limiting speed
n_{gr}	460 1/min	Reference speed
$\approx m$	86,4 kg	Weight

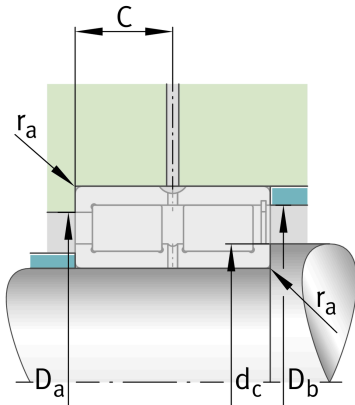



Mounting dimensions

$d_{c \text{ min}}$	318 mm	Minimum shaft shoulder
$d_{a \text{ min}}$	318,3 mm	Minimum diameter shaft shoulder
$D_{a \text{ max}}$	374,5 mm	Maximum diameter of housing shoulder
$r_{a \text{ max}}$	4 mm	Maximum recess radius
$D_{e \text{ min}}$	372,3 mm	Minimum diameter of housing shoulder





Dimensions

r_{min}	4 mm	Minimum chamfer dimension
$r_{1 \text{ min}}$	4 mm	Minimum chamfer dimension
s	11,3 mm	Axial displacement
C	95 mm	Distance to lubrication hole
d_1	318,3 mm	Maximum rib diameter inner ring
$D_1 \text{ min}$	372,3 mm	Minimum rib diameter outer ring
E	390,3 mm	Raceway diameter outer ring

Temperature range

T_{min}	-30 °C	Operating temperature min.
T_{max}	120 °C	Operating temperature max.

Characteristics

	Radial load
	Axial load in one direction
	Grease Lubrication
	Oil Lubrication
	Not sealed
	Large bearing