

ZKLF3080-2RS-2AP-XL

Axial angular contact ball bearing

Axial angular contact ball bearings
ZKLF.-2RS-2AP-XL, matched pair, double
direction, lip seals on both sides

X-life

Technical information



Your current product variant

Number of bearings	2AP	Axial angular contact ball bearings, matched pair
Sealing	2RS	Contact lip seals on both sides
Tolerance class	Standard	

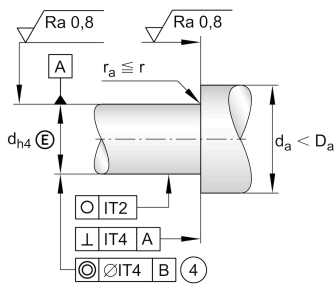
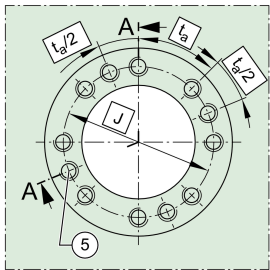
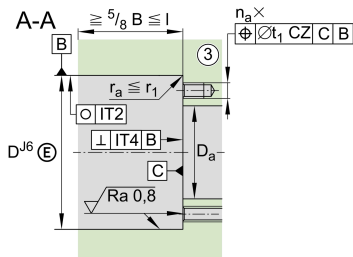
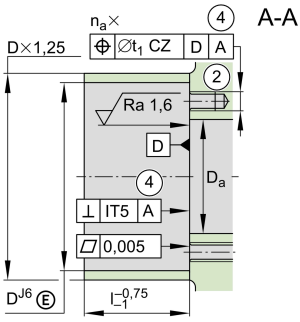

Main Dimensions & Performance Data

d	30 mm	Bore diameter
	0 mm	Bore diameter upper tolerance
	-0,005 mm	Bore diameter lower tolerance
D	80 mm	Outside diameter
	0 mm	Outside diameter upper tolerance
	-0,01 mm	Outside diameter lower tolerance
B	56 mm	Width
	0 mm	Width upper tolerance
	-0,5 mm	Width lower tolerance
C _a	52.000 N	Basic dynamic load rating, axial
C _{0a}	127.000 N	Basic static load rating, axial
C _{ua}	7.700 N	Fatigue load limit, axial
n _G Grease	5.000 1/min	Limiting speed for grease lubrication
n _g	2.200 1/min	Thermally safe operating speed
M _R	0,75 Nm	Bearing frictional torque
≈m	1,464 kg	Weight

Mounting dimensions

D _{a max}	53 mm	Maximum diameter of housing
d _{a min}	40 mm	Minimum diameter shaft
t ₁	0,1 mm	Position tolerance of bore in the housing
	M6X70	Size of fixing screws
n _a	11	Number of holes in adjacent construction
t _a	30 °	Pitch separation angle of holes in adjacent construction
	M6	Connection thread for lubrication



Dimensions

d_1	45,5 mm	Rib diameter inner ring
r_{\min}	0,3 mm	Minimum chamfer dimension
$r_{1 \min}$	0,6 mm	Minimum chamfer dimension
J	63 mm	Pitch circle diameter fixing holes
d_2	6,8 mm	Fixing holes diameter
b	3 mm	Width of extraction slot
l	47 mm	Distance of extraction slot
n	11	Pitch quantity of fixing holes
t	30 °	Pitch separation angle of fixing holes
a	60 °	Contact angle

Temperature range

T_{\min}	-30 °C	Operating temperature min.
T_{\max}	120 °C	Operating temperature max.

Additional information

c_{aL}	1.500 N/ μ m	Rigidity axial
c_{kL}	620 Nm/mrad	Tilting rigidity
M_m	1,46 kg*cm ²	Mass moment of inertia
	2,5 μ m	Axial runout
	ZMA30/52	Recommended INA precision locknut for radial locking
	AM30	Recommended INA precision locknut for axial locking
M_A	32 Nm	Tightening torque for the recommended INA precision locknut
	9.947 N	Required locknut force axial



Characteristics



Radial load



Axial load in one direction



Axial load in two directions



Lifetime lubrication, freedom from maintenance



Grease Lubrication



Sealed on both sides