

**ZKLF30100-2Z-XL**

Axial angular contact ball bearing

Axial angular contact ball bearings ZKLF..-2Z, double direction, for screw mounting, gap seals on both sides

X-life

Technical information

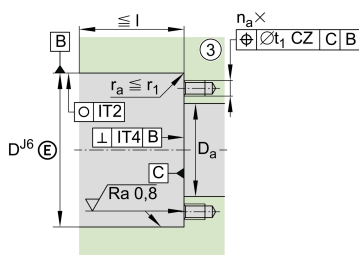
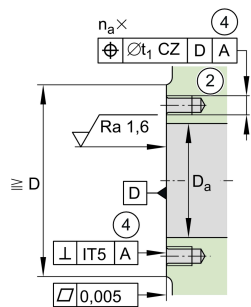
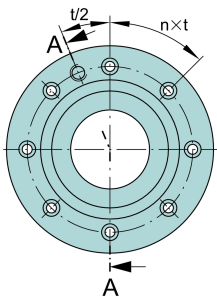
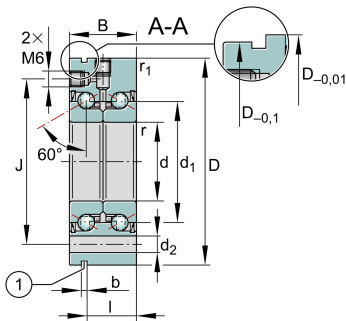

Your current product variant

Sealing	2Z	Minimal gap seal on both sides
Tolerance class	Standard	

Main Dimensions & Performance Data

d	30 mm	Bore diameter
	0 mm	Bore diameter upper tolerance
	-0,005 mm	Bore diameter lower tolerance
D	100 mm	Outside diameter
	0 mm	Outside diameter upper tolerance
	-0,01 mm	Outside diameter lower tolerance
B	38 mm	Width
	0 mm	Width upper tolerance
	-0,25 mm	Width lower tolerance
C _a	65.000 N	Basic dynamic load rating, axial
C _{0a}	108.000 N	Basic static load rating, axial
C _{ua}	6.500 N	Fatigue load limit, axial
n _G Grease	5.600 1/min	Limiting speed for grease lubrication
n _g	4.000 1/min	Thermally safe operating speed
M _R	0,4 Nm	Bearing frictional torque
≈m	1,686 kg	Weight



Mounting dimensions

$D_{a \max}$	64 mm	Maximum diameter of housing
$d_{a \min}$	47 mm	Minimum diameter shaft
t_1	0,2 mm	Position tolerance of bore in the housing
	M8	Size of fixing screws
n_a	8	Number of holes in adjacent construction
t_a	45 °	Pitch separation angle of holes in adjacent construction
	M6	Connection thread for lubrication

Dimensions

d_1	51 mm	Rib diameter inner ring
r_{\min}	0,3 mm	Minimum chamfer dimension
$r_{1 \min}$	0,6 mm	Minimum chamfer dimension
J	80 mm	Pitch circle diameter fixing holes
d_2	8,8 mm	Fixing holes diameter
b	3 mm	Width of extraction slot
l	30 mm	Distance of extraction slot
n	8	Pitch quantity of fixing holes
t	45 °	Pitch separation angle of fixing holes
a	60 °	Contact angle

Temperature range







T_{\min}	-30 °C	Operating temperature min.
T_{\max}	120 °C	Operating temperature max.



Additional information

c_{aL}	950 N/μm	Rigidity axial
c_{kL}	400 Nm/mrad	Tilting rigidity
M_m	1,91 kg*cm ²	Mass moment of inertia
	2,5 μm	Axial runout
	ZMA30/52	Recommended INA precision locknut for radial locking
	AM30	Recommended INA precision locknut for axial locking
M_A	65 Nm	Tightening torque for the recommended INA precision locknut
	19.509 N	Required locknut force axial

Characteristics

-  Radial load
-  Axial load in one direction
-  Axial load in two directions
-  Lifetime lubrication, freedom from maintenance
-  Grease Lubrication
-  Sealed on both sides