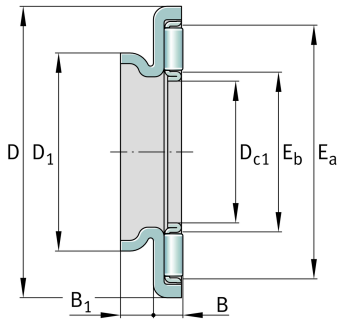

**AXW50**

Axial needle roller bearing

Axial needle roller bearings, single direction,
AXK with axial bearing washer

Technical information

**Main Dimensions & Performance Data**

| | | |
|----------|-------------|-----------------------------------|
| D_{c1} | 50 mm | Bore diameter cage |
| D | 73 mm | Outside diameter bearing washer |
| B | 4,2 mm | Height bearing |
| B_1 | 4,5 mm | Height centering collar |
| D_1 | 58 mm | Outside diameter centering collar |
| E_a | 68 mm | Raceway dimension |
| E_b | 55 mm | Raceway dimension |
| C | 32.000 N | Basic dynamic load rating, axial |
| C_{0a} | 143.000 N | Basic static load rating, axial |
| c_{ua} | 15.100 N | Fatigue load limit, axial |
| n_G | 4.800 1/min | Limiting speed |
| n_{gr} | 2.230 1/min | Reference speed |
| m | 48,94 g | Weight |

Additional information

| | |
|-----------|---|
| AS5070 | Axial bearing washer |
| HK5022-RS | Drawn cup needle roller bearings turned |
| HK5025 | Drawn cup needle roller bearings |
| HK5020 | Drawn cup needle roller bearings for radial bearing arrangement |
| NKIS35 | Needle roller bearings with inner ring |
| NKS43 | Needle roller bearings with out inner ring |

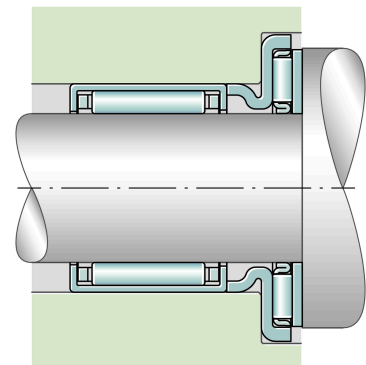
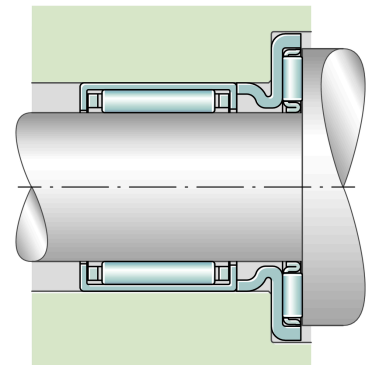







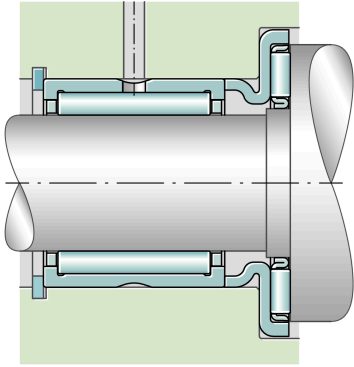

View product details on medias

13.06.2026, 16:16:39 UTC

SCHAEFFLER



Characteristics

-  Axial load in one direction
-  Grease Lubrication
-  Oil Lubrication
-  Not sealed
-  Small design envelope