



FAG

29430-E1-XL-N1

Axial spherical roller bearing

Axial spherical roller bearing 294..-E1-XL, no flanging ring

X-life

Technical information

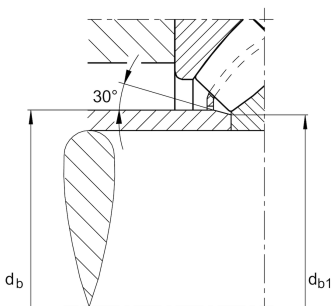
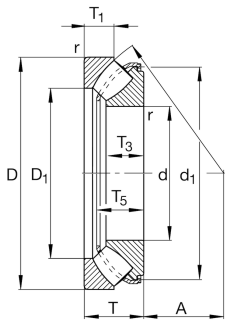

Your current product variant

Heat treatment	Standard	Standard
Locating feature, housing washer	N1	Locating feature, housing washer
Cage	JP	Sheet metal cage
Handling thread holes	Without	
Constricted width and inclination variation	Standard	
Test certificate	Without	

Main Dimensions & Performance Data

d	150 mm	Bore diameter
D	300 mm	Outside diameter
T	90 mm	Height
C _a	2.000.000 N	Basic dynamic load rating, axial
C _{0a}	5.300.000 N	Basic static load rating, axial
C _{ua}	560.000 N	Fatigue load limit, axial
n _G	2.290 1/min	Limiting speed
n _{gr}	1.180 1/min	Reference speed
≈m	26,48 kg	Weight



Mounting dimensions

$d_{a \min}$	220 mm	Minimum diameter shaft shoulder
$D_{a \max}$	253 mm	Maximum diameter of housing shoulder
$D_{b \min}$	306 mm	Minimum bore diameter housing
$d_{b \max}$	175 mm	Maximum distance sleeve
$d_{b1 \max}$	164 mm	Maximum chamfer diameter of distance sleeve
$r_{a \max}$	3 mm	Maximum recess radius
	30 °	Angle of chamfer of the distance sleeve

Dimensions

D_1	207,5 mm	Bore diameter housing washer
d_1	267,4 mm	Rip diameter shaft washer
r_{\min}	4 mm	Minimum chamfer dimension
T_1	43,4 mm	Height of the housing washer
T_3	58 mm	Height of the shaft washer
T_5	80,5 mm	Distance shaft washer - cage
A	92 mm	Distance of the center point

Temperature range

T_{\min}	-30 °C	Operating temperature min.
T_{\max}	200 °C	Operating temperature max.



Characteristics



Radial load



Axial load in one direction



Grease Lubrication



Oil Lubrication



Not sealed



Static angular error and misalignment



Dynamic angular error and misalignment