**NX30-XL**

Needle roller/axial ball bearing

Needle roller/axial ball bearings NX, single direction axial component, for oil lubrication

X-life

Technical information

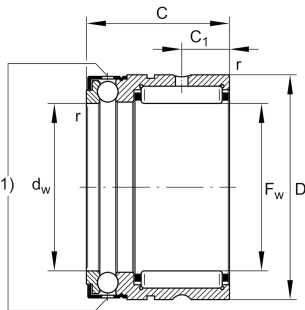
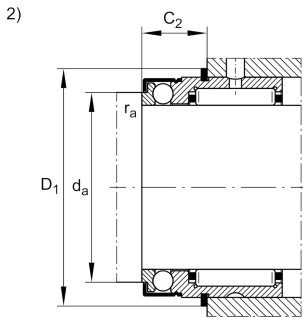

Your current product variant

Sealing	Without
Cage	Standard

Main Dimensions & Performance Data

F_w	30 mm	Bore diameter
D	42 mm	Outside diameter
C	30 mm	Height
C_r	25.500 N	Basic dynamic load rating, radial
C_{0r}	36.000 N	Basic static load rating, radial
C_a	11.700 N	Basic dynamic load rating, axial
C_{0a}	28.000 N	Basic static load rating, axial
C_{ur}	6.400 N	Fatigue load limit, radial
C_{ua}	1.270 N	Fatigue load limit, axial
n_G	4.300 1/min	Limiting speed
$\approx m$	120,39 g	Weight



Mounting dimensions

d_a	36,5 mm	Mounting dimension shaft shoulder
$r_{a \max}$	0,3 mm	Maximum recess radius
D_1	45,1 mm	Connection diameter snap ring
C_2	14,2 mm	Connection width with snap ring

Dimensions

C_1	10 mm	Distance to lubrication hole
C_2	10 mm	Distance to lubrication hole
d_w	30 mm	Bore diameter of shaft washer
r_{\min}	0,3 mm	Minimum chamfer dimension





Temperature range

T_{\min}	-30 °C	Operating temperature min.
T_{\max}	120 °C	Operating temperature max.

Additional information

IR25X30X20-XL	Suitable inner rings IR
WR42, SW42	Snap ring

Characteristics

	Radial load
	Axial load in one direction
	Grease Lubrication
	Oil Lubrication
	Not sealed