

**NX35-XL**

## Needle roller/axial ball bearing

Needle roller/axial ball bearings NX, single direction axial component, for oil lubrication

X-life

## Technical information

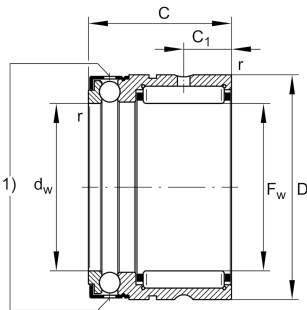
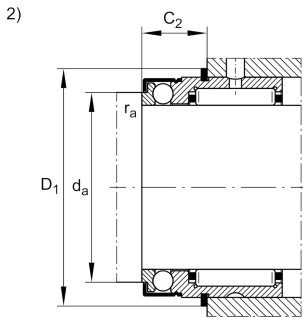

## Your current product variant

Sealing	Without
Cage	Standard

## Main Dimensions &amp; Performance Data

$F_w$	35 mm	Bore diameter
$D$	47 mm	Outside diameter
$C$	30 mm	Height
$C_r$	27.500 N	Basic dynamic load rating, radial
$C_{0r}$	41.500 N	Basic static load rating, radial
$C_a$	12.400 N	Basic dynamic load rating, axial
$C_{0a}$	32.500 N	Basic static load rating, axial
$C_{ur}$	7.400 N	Fatigue load limit, radial
$C_{ua}$	1.480 N	Fatigue load limit, axial
$n_G$	3.700 1/min	Limiting speed
$\approx m$	0,137 kg	Weight



### Mounting dimensions

$d_a$	40,5 mm	Mounting dimension shaft shoulder
$r_{a \max}$	0,3 mm	Maximum recess radius
$D_1$	50,1 mm	Connection diameter snap ring
$C_2$	14,2 mm	Connection width with snap ring

### Dimensions

$C_1$	10 mm	Distance to lubrication hole
$C_2$	10 mm	Distance to lubrication hole
$d_w$	35 mm	Bore diameter of shaft washer
$r_{\min}$	0,3 mm	Minimum chamfer dimension





### Temperature range

$T_{\min}$	-30 °C	Operating temperature min.
$T_{\max}$	120 °C	Operating temperature max.

### Additional information

IR30X35X20-XL	Suitable inner rings IR
WR47, SW47	Snap ring

### Characteristics

	Radial load
	Axial load in one direction
	Grease Lubrication
	Oil Lubrication
	Not sealed