**NKXR17-XL**

Needle roller/axial cylindrical roller bearing

Needle roller/axial cylindrical roller bearings
NKXR, axial component, single direction, to
DIN 5429, without end cap, for oil lubrication

X-life

Technical information

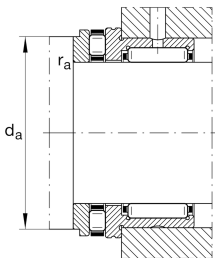
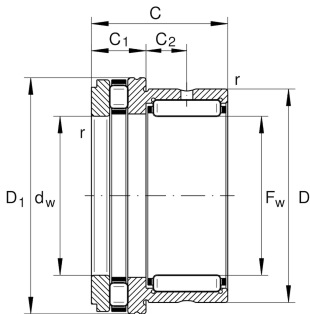

Your current product variant

Sealing	Without	
Tolerance class	PN	Normal (PN)

Main Dimensions & Performance Data

F_w	17 mm	Bore diameter
D	26 mm	Outside diameter
C	25 mm	Height
C_r	13.500 N	Basic dynamic load rating, radial
C_{0r}	15.000 N	Basic static load rating, radial
C_a	16.000 N	Basic dynamic load rating, axial
C_{0a}	33.500 N	Basic static load rating, axial
C_{ur}	2.800 N	Fatigue load limit, radial
C_{ua}	4.700 N	Fatigue load limit, axial
n_G	12.000 1/min	Limiting speed
n_{gr}	5.500 1/min	Reference speed
$\approx m$	49,93 g	Weight

Mounting dimensions

d_a	25,7 mm	Mounting dimension shaft shoulder
$r_{a \max}$	0,3 mm	Maximum recess radius



Dimensions

D 1 max	30,1 mm	Maximum outside diameter flange
C 1	9 mm	Width of the axial bearing component
C 2	8 mm	Distance to lubrication hole
d _w	17 mm	Bore diameter of shaft washer
r _{min}	0,3 mm	Minimum chamfer dimension





Temperature range

T _{min}	-30 °C	Operating temperature min.
T _{max}	120 °C	Operating temperature max.

Additional information

IR14X17X17-XL Suitable inner rings IR

Characteristics

-  Radial load
-  Axial load in one direction
-  Grease Lubrication
-  Oil Lubrication
-  Not sealed