

**NKXR45-XL**

Needle roller/axial cylindrical roller bearing

Needle roller/axial cylindrical roller bearings
NKXR, axial component, single direction, to
DIN 5429, without end cap, for oil lubrication

X-life

Technical information

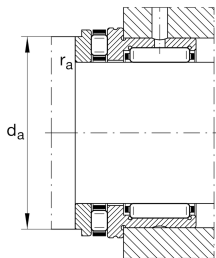
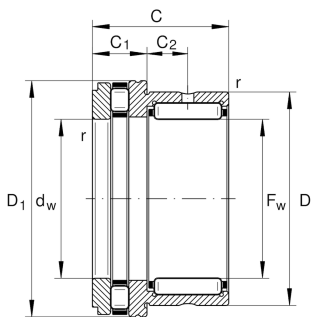

Your current product variant

Type of Seal	Without	
Tolerance class	PN	Normal (PN)

Main Dimensions & Performance Data

F_w	45 mm	Bore diameter
D	58 mm	Outside diameter
C	32 mm	Height
C_r	31.000 N	Basic dynamic load rating, radial
C_{0r}	53.000 N	Basic static load rating, radial
C_a	59.000 N	Basic dynamic load rating, axial
C_{0a}	163.000 N	Basic static load rating, axial
C_{ur}	9.400 N	Fatigue load limit, radial
C_{ua}	16.300 N	Fatigue load limit, axial
n_G	5.000 1/min	Limiting speed
n_{gr}	1.900 1/min	Reference speed
$\approx m$	243,61 g	Weight

Mounting dimensions

d_a	60,6 mm	Mounting dimension shaft shoulder
$r_{a \max}$	0,6 mm	Maximum recess radius



Dimensions

D 1 max	65,2 mm	Maximum outside diameter flange
C 1	14 mm	Width of the axial bearing component
C 2	9 mm	Distance to lubrication hole
d _w	45 mm	Bore diameter of shaft washer
r _{min}	0,6 mm	Minimum chamfer dimension





Temperature range

T _{min}	-30 °C	Operating temperature min.
T _{max}	120 °C	Operating temperature max.

Additional information

IR40X45X20-XL	Suitable inner rings IR
---------------	-------------------------

Characteristics

-  Radial load
-  Axial load in one direction
-  Grease Lubrication
-  Oil Lubrication
-  Not sealed