

**PASEY17-XL**

Plummer block housing unit

Plummer block housing units PASEY, cast iron housing, radial insert ball bearing with grub screws in inner ring, P seals

X-life

Technical information

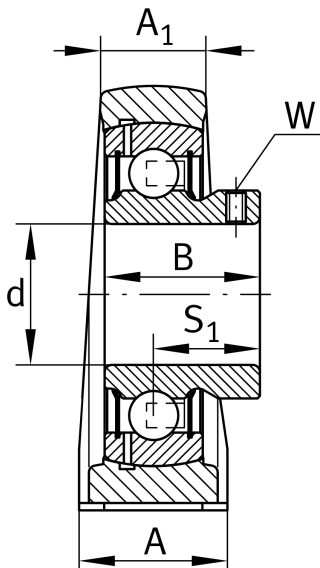
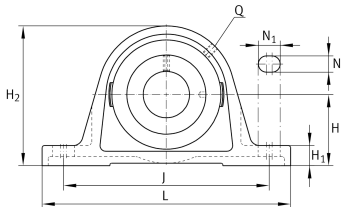

Your current product variant

Material	GG	Grey cast iron
----------	----	----------------

Main Dimensions & Performance Data

d	17 mm	Bore diameter
L	125 mm	Length total
H ₂	57 mm	Height
≈m	0,4 kg	Weight

Mounting dimensions

J	95 mm	Distance fixing bore
N	11 mm	Width (slot)
N ₁	19 mm	Length (slot)

Dimensions

H	30,2 mm	Distance shaft axis
A	30 mm	Width (base)
A ₁	18 mm	Width (head)
H ₁	10 mm	Height (base)
B	22 mm	Width
S ₁	16 mm	Distance of raceway to locking collar
Q	M6	Connection thread for lubrication



Additional information

ASE03	Housing
GAY17-XL-NPP-B	Bearing designation

Temperature range

T _{min}	-20 °C	Operating temperature min.
T _{max}	120 °C	Operating temperature max.