

**RASE100-XL**

## Plummer block housing unit

Plummer block housing units RASE, cast iron housing, radial insert ball bearing with eccentric locking collar, R seals

X-life

## Technical information



## Your current product variant

Material	GG	Grey cast iron
----------	----	----------------

## Main Dimensions &amp; Performance Data

d	100 mm	Bore diameter
L	380 mm	Length total
H <sub>2</sub>	225 mm	Height
≈m	18,03 kg	Weight

## Mounting dimensions

J	308 mm	Distance fixing bore
N	30 mm	Width (slot)
N <sub>1</sub>	38 mm	Length (slot)

## Dimensions

H	115 mm	Distance shaft axis
A	95 mm	Width (base)
A <sub>1</sub>	62 mm	Width (head)
H <sub>1</sub>	40 mm	Height (base)
B <sub>1</sub>	75 mm	Locking collar total width
S <sub>1</sub>	49,5 mm	Distance of raceway to locking collar
Q	M6	Connection thread for lubrication

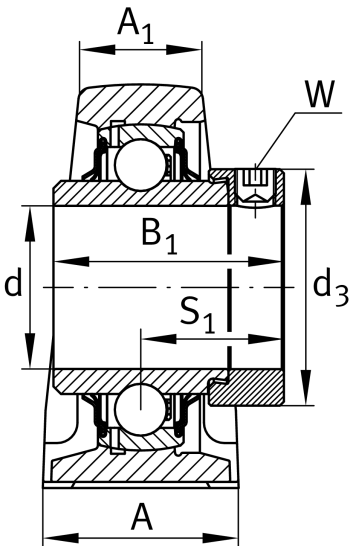



View product details on medias

22.04.2026, 12:16:07 UTC

SCHAEFFLER

### Additional information

ASE20	Housing
GE100-XL-KRR-B	Bearing designation

### Temperature range

T <sub>min</sub>	-20 °C	Operating temperature min.
T <sub>max</sub>	120 °C	Operating temperature max.