

**RSAO35-XL**

Plummer block housing unit

Plummer block housing units RSAO, cast iron housing, radial insert ball bearing with eccentric locking collar, R seals

X-life

Technical information



Your current product variant

Material	GG	Grey cast iron
----------	----	----------------

Main Dimensions & Performance Data

d	35 mm	Bore diameter
L	210 mm	Length total
H ₂	106 mm	Height
≈m	2,43 kg	Weight

Mounting dimensions

J	160 mm	Distance fixing bore
N	17,5 mm	Width (slot)
N ₁	25,5 mm	Length (slot)

Dimensions

H	56 mm	Distance shaft axis
A	56 mm	Width (base)
A ₁	30 mm	Width (head)
H ₁	20 mm	Height (base)
B ₁	51,6 mm	Locking collar total width
S ₁	33,3 mm	Distance of raceway to locking collar
Q	M6	Connection thread for lubrication

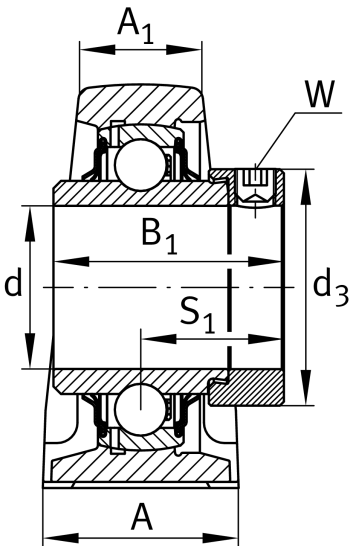



Additional information

SAO07	Housing
GNE35-XL-KRR-B	Bearing designation

Temperature range

T _{min}	-20 °C	Operating temperature min.
T _{max}	120 °C	Operating temperature max.