

**PSHEY15-XL**

Plummer block housing unit

Plummer block housing units PSHEY, cast iron housing, radial insert ball bearing with grub screws in inner ring, P seals

X-life

Technical information

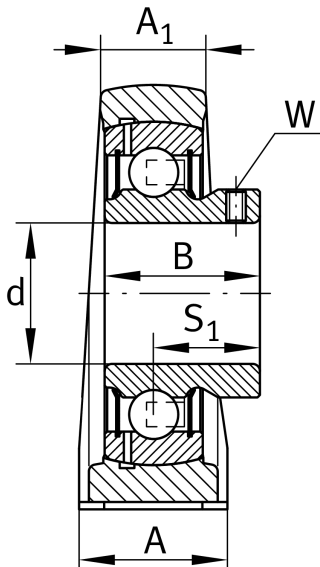

Your current product variant

Material	GG	Grey cast iron
----------	----	----------------

Main Dimensions & Performance Data

d	15 mm	Bore diameter
L	63 mm	Length total
H ₂	57 mm	Height
≈m	0,4 kg	Weight

Mounting dimensions

J	47 mm	Distance fixing bore
K	M8	Thread fixing bore

Dimensions

H	30,2 mm	Distance shaft axis
A	30 mm	Width (base)
A ₁	18 mm	Width (head)
Q	M6	Connection thread for lubrication
B	22 mm	Width of inner ring
S ₁	16 mm	Distance of raceway to locking collar



Additional information

SHE03	Housing
GAY15-XL-NPP-B	Bearing designation

Temperature range

T _{min}	-20 °C	Operating temperature min.
T _{max}	120 °C	Operating temperature max.