

**TSHE20-XL-N**

Plummer block housing unit

Plummer block housing units TSHE, cast iron housing, radial insert ball bearing with eccentric locking collar, T seals

X-life

Technical information

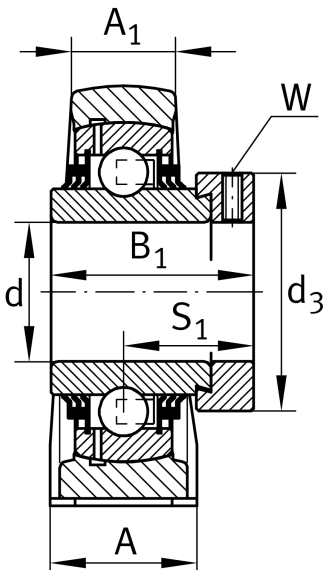

Your current product variant

Groove	N	Cast iron housing with undercut slot for end caps
Material	GG	Grey cast iron

Main Dimensions & Performance Data

d	20 mm	Bore diameter
L	65 mm	Length total
H ₂	64 mm	Height
≈m	0,49 kg	Weight

Mounting dimensions

J	50,8 mm	Distance fixing bore
K	M8	Thread fixing bore

Dimensions

H	33,3 mm	Distance shaft axis
A	32 mm	Width (base)
A ₁	19 mm	Width (head)
Q	M6	Connection thread for lubrication
S ₁	26,6 mm	Distance of raceway to locking collar



Additional information

SHE04	Housing
GE20-XL-KTT-B	Bearing designation
KASK04	Protecting cap

Temperature range

T _{min}	-20 °C	Operating temperature min.
T _{max}	120 °C	Operating temperature max.