

**GRA30-XL**

Flanged housing unit

Housing units GRA, three/four-bolt flanged housing units, sheet steel, eccentric locking collar, P seals

X-life

Technical information

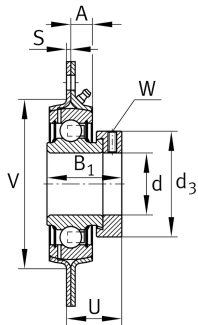
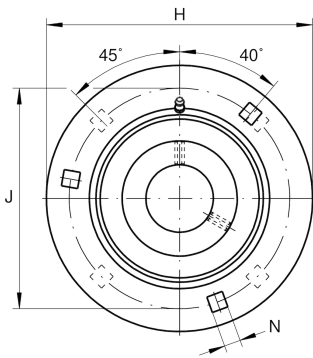

Your current product variant

Material	Steel sheet
----------	-------------

Main Dimensions & Performance Data

d	30 mm	Bore diameter
H	112,7 mm	Height flange
H	112,7 mm	Flange width
U	29,2 mm	Total height unit
B ₁	35,8 mm	Locking collar total width
C _{ur}	480 N	Fatigue load limit, radial
C _r	20.700 N	Basic dynamic load rating, radial
C _{0r}	11.300 N	Basic static load rating, radial
C _{0rG}	5.000 N	Load carrying capacity (housing)
≈m	0,64 kg	Weight

Mounting dimensions

J	90,5 mm	Pitch circle diameter (holes)
N	10,5 mm	Fixing square
n	3	Number of screwing holes
n	3	Number of screws



Dimensions

A	8,7 mm	Height housing
S	2,5 mm	Thickness of flange
V	71 mm	Shoulder diameter housing
d ₃	37,5 mm	Outside diameter eccentric locking collar
d ₃	44 mm	Outside diameter locking collar/locknut

Additional information

1	Number of housings
1	Number of housings 2
FLAN62-MSB	Housing
FLAN62-MSA	Housing (Part 2)
EXZ	Fixing
GRAE30-XL-NPP-B	Bearing designation

Temperature range

T _{min}	-20 °C	Operating temperature min.
T _{max}	120 °C	Operating temperature max.