

**PCJTY15-XL**

Flanged housing unit

Housing units PCJTY, two-bolt flanged housing units, cast iron, grub screws in inner ring, P seals

X-life

Technical information

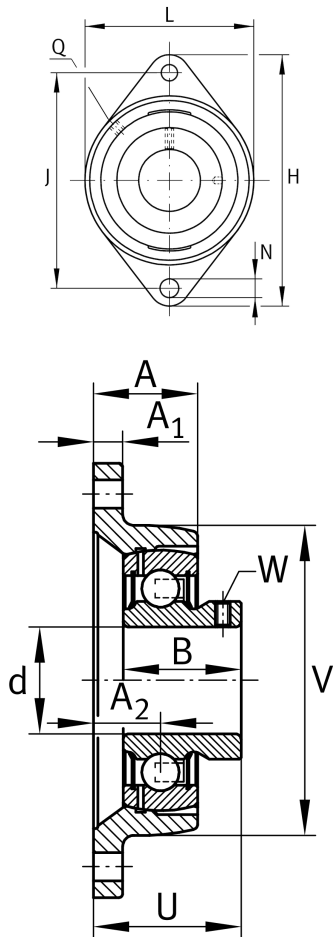

Your current product variant

Material	GG	Grey cast iron
----------	----	----------------

Main Dimensions & Performance Data

d	15 mm	Bore diameter
L	57 mm	Flange width
H	99 mm	Height flange
U	33 mm	Total height unit
C _r	10.100 N	Basic dynamic load rating, radial
C _{0r}	4.750 N	Basic static load rating, radial
C _{ur}	202 N	Fatigue load limit, radial
≈m	0,34 kg	Weight

Mounting dimensions

J	76,5 mm	Distance fixing bore
N	11,5 mm	Fixing bore
n	2	Number of screwing holes



Dimensions

A	25 mm	Height housing
A ₁	9,5 mm	Thickness of flange
A ₂	17 mm	Distance raceway
B	22 mm	Width
V	57 mm	Shoulder diameter housing
Q	M6	Connection thread for lubrication

Additional information

1	Number of housings
CJT03	Housing
GAY15-XL-NPP-B	Bearing designation

Temperature range

T _{min}	-20 °C	Operating temperature min.
T _{max}	120 °C	Operating temperature max.