

**RAT17-XL**

Flanged housing unit

Housing units RAT, two-bolt flanged housing units, sheet steel, eccentric locking collar, P seals

X-life

Technical information

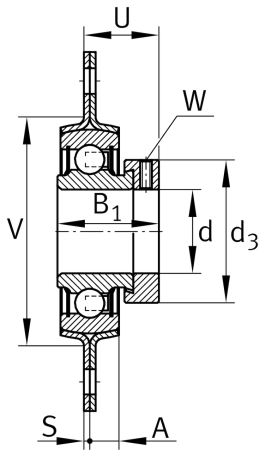
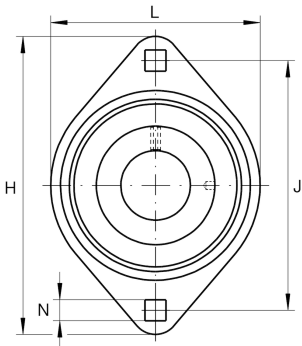

Your current product variant

Material	Steel sheet
----------	-------------

Main Dimensions & Performance Data

d	17 mm	Bore diameter
L	58,7 mm	Flange width
H	81 mm	Height flange
H	81 mm	Flange width
U	24 mm	Total height unit
C _r	9.800 N	Basic dynamic load rating, radial
C _{0r}	4.750 N	Basic static load rating, radial
C _{ur}	248 N	Fatigue load limit, radial
C _{0rG}	2.700 N	Load carrying capacity (housing)
C _g	2.700 N	Load carrying capacity (housing)
m	0,19 kg	Weight

Mounting dimensions

J	63,5 mm	Distance fixing bore
N	7,1 mm	Fixing square
n	2	Number of screwing holes



Dimensions

A	7 mm	Height housing
S ₁	2 mm	Thickness of flange
S	2 mm	Thickness of flange
V	48 mm	Shoulder diameter housing

Additional information

2	Number of housings
FLAN40-MST	Housing
RAE17-XL-NPP-B	Bearing designation

Temperature range

T _{min}	-20 °C	Operating temperature min.
T _{max}	120 °C	Operating temperature max.