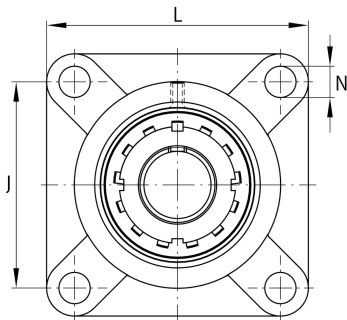
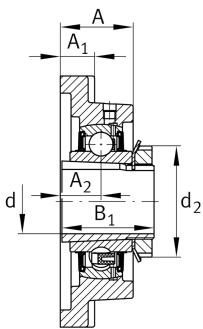
**FAG****UKF205**

Flanged housing unit

Flanged housing unit UKF

Technical information

**Your current product variant**

Material	GG	Grey cast iron
----------	----	----------------

Main Dimensions & Performance Data

d	20 mm	Bore diameter
L	95 mm	Flange width
C_r	14.000 N	Basic dynamic load rating, radial
C_{0r}	7.800 N	Basic static load rating, radial
C_{ur}	410 N	Fatigue load limit, radial
$\approx m$	0,9 kg	Weight

Mounting dimensions

J	70 mm	Distance fixing bore
N	12 mm	Fixing bore
n	4	Number of screwing holes

Dimensions

A	27 mm	Height housing
A_1	14 mm	Thickness of flange
A_2	16 mm	Distance raceway
B	23 mm	Width
B_1	35 mm	Locking collar total width
d_3	38 mm	Outside diameter eccentric locking collar



Additional information

1	Number of housings
F205	Housing
UK205	Bearing designation

Temperature range

T _{min}	-20 °C	Operating temperature min.
T _{max}	120 °C	Operating temperature max.