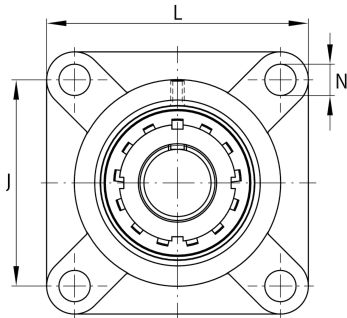
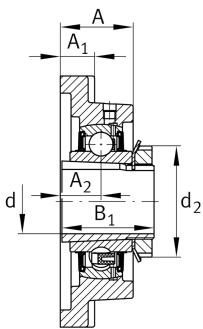

**FAG****UKF211**

Flanged housing unit

Flanged housing unit UKF

Technical information

**Your current product variant**

Material	GG	Grey cast iron
----------	----	----------------

Main Dimensions & Performance Data

d	50 mm	Bore diameter
L	163 mm	Flange width
C _r	46.000 N	Basic dynamic load rating, radial
C _{0r}	29.000 N	Basic static load rating, radial
C _{ur}	1.520 N	Fatigue load limit, radial
≈m	3,48 kg	Weight

Mounting dimensions

J	130 mm	Distance fixing bore
N	19 mm	Fixing bore
n	4	Number of screwing holes

Dimensions

A	43 mm	Height housing
A ₁	20 mm	Thickness of flange
A ₂	25 mm	Distance raceway
B	36 mm	Width
B ₁	59 mm	Locking collar total width
d ₃	75 mm	Outside diameter eccentric locking collar



Additional information

1	Number of housings
F211	Housing
UK211	Bearing designation

Temperature range

T _{min}	-20 °C	Operating temperature min.
T _{max}	120 °C	Operating temperature max.