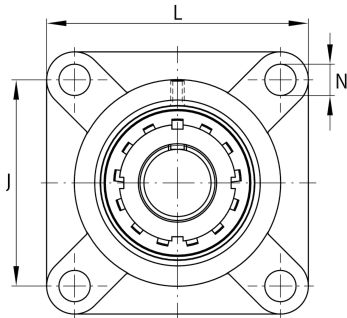
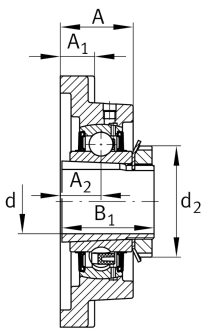

**FAG****UKF217**

Flanged housing unit

Flanged housing unit UKF

## Technical information

**Your current product variant**

Material	GG	Grey cast iron
----------	----	----------------

**Main Dimensions & Performance Data**

d	75 mm	Bore diameter
L	220 mm	Flange width
C <sub>r</sub>	88.000 N	Basic dynamic load rating, radial
C <sub>0r</sub>	64.000 N	Basic static load rating, radial
C <sub>ur</sub>	3.050 N	Fatigue load limit, radial
≈m	9,55 kg	Weight

**Mounting dimensions**

J	175 mm	Distance fixing bore
N	23 mm	Fixing bore
n	4	Number of screwing holes

**Dimensions**

A	63 mm	Height housing
A <sub>1</sub>	26 mm	Thickness of flange
A <sub>2</sub>	36 mm	Distance raceway
B	48 mm	Width
B <sub>1</sub>	82 mm	Locking collar total width
d <sub>3</sub>	110 mm	Outside diameter eccentric locking collar



### Additional information

---

1	Number of housings
F217	Housing
UK217	Bearing designation

### Temperature range

---

T <sub>min</sub>	-20 °C	Operating temperature min.
T <sub>max</sub>	120 °C	Operating temperature max.