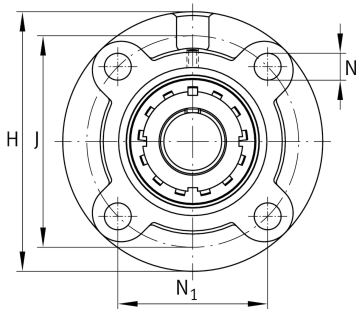

**FAG****UKFC205**

Flanged housing unit

Flanged housing unit UKFC

## Technical information

**Your current product variant**

Material	GG	Grey cast iron
----------	----	----------------

**Main Dimensions & Performance Data**

d	20 mm	Bore diameter
H	115 mm	Height flange
U	30,7 mm	Total height unit
C <sub>r</sub>	14.900 N	Basic dynamic load rating, radial
C <sub>0r</sub>	7.800 N	Basic static load rating, radial
C <sub>ur</sub>	410 N	Fatigue load limit, radial
≈m	0,99 kg	Weight

**Mounting dimensions**

J	90 mm	Pitch circle diameter (holes)
N	12 mm	Fixing bore
N <sub>1</sub>	63,6 mm	Distance fixing bore
T <sub>1</sub>	6 mm	Height spigot
Z	70 mm	Diameter spigot
	h8	Diameter spigot clearance
n	4	Number of screwing holes



### Dimensions

A	21 mm	Height housing
A <sub>1</sub>	7 mm	Thickness of flange
A <sub>2</sub>	10 mm	Distance raceway
B	23 mm	Width
B <sub>1</sub>	35 mm	Locking collar total width
d <sub>3</sub>	38 mm	Outside diameter eccentric locking collar

### Additional information

1	Number of housings
FC205	Housing
UK205	Bearing designation

### Temperature range

T <sub>min</sub>	-20 °C	Operating temperature min.
T <sub>max</sub>	120 °C	Operating temperature max.