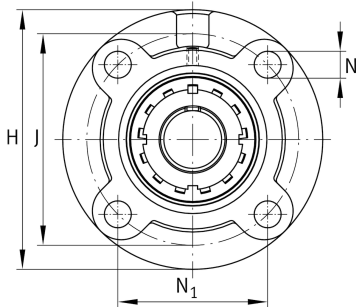

**FAG****UKFC208**

Flanged housing unit

Flanged housing unit UKFC

Technical information

**Your current product variant**

Material	GG	Grey cast iron
----------	----	----------------

Main Dimensions & Performance Data

d	35 mm	Bore diameter
H	145 mm	Height flange
U	37,7 mm	Total height unit
C _r	32.500 N	Basic dynamic load rating, radial
C _{0r}	19.800 N	Basic static load rating, radial
C _{ur}	1.030 N	Fatigue load limit, radial
≈m	2,12 kg	Weight

Mounting dimensions

J	120 mm	Pitch circle diameter (holes)
N	14 mm	Fixing bore
N ₁	84,8 mm	Distance fixing bore
T ₁	10 mm	Height spigot
Z	100 mm	Diameter spigot
	h8	Diameter spigot clearance
n	4	Number of screwing holes



Dimensions

A	26 mm	Height housing
A ₁	9 mm	Thickness of flange
A ₂	11 mm	Distance raceway
B	31 mm	Width
B ₁	46 mm	Locking collar total width
d ₃	58 mm	Outside diameter eccentric locking collar

Additional information

1	Number of housings
FC208	Housing
UK208	Bearing designation

Temperature range

T _{min}	-20 °C	Operating temperature min.
T _{max}	120 °C	Operating temperature max.