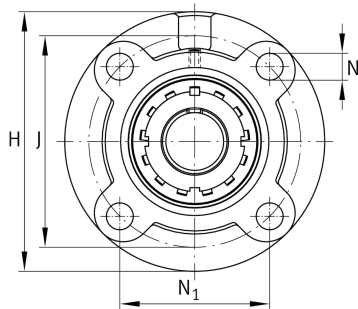
**FAG****UKFC209**

Flanged housing unit

Flanged housing unit UKFC

## Technical information

**Your current product variant**

Material	GG	Grey cast iron
----------	----	----------------

**Main Dimensions & Performance Data**

d	40 mm	Bore diameter
H	160 mm	Height flange
U	38,2 mm	Total height unit
C <sub>r</sub>	34.500 N	Basic dynamic load rating, radial
C <sub>0r</sub>	20.400 N	Basic static load rating, radial
C <sub>ur</sub>	1.060 N	Fatigue load limit, radial
≈m	2,82 kg	Weight

**Mounting dimensions**

J	132 mm	Pitch circle diameter (holes)
N	16 mm	Fixing bore
N <sub>1</sub>	93,3 mm	Distance fixing bore
T <sub>1</sub>	12 mm	Height spigot
Z	105 mm	Diameter spigot
	h8	Diameter spigot clearance
n	4	Number of screwing holes



### Dimensions

A	26 mm	Height housing
A <sub>1</sub>	14 mm	Thickness of flange
A <sub>2</sub>	10 mm	Distance raceway
B	32 mm	Width
B <sub>1</sub>	50 mm	Locking collar total width
d <sub>3</sub>	65 mm	Outside diameter eccentric locking collar

### Additional information

1	Number of housings
FC209	Housing
UK209	Bearing designation

### Temperature range

T <sub>min</sub>	-20 °C	Operating temperature min.
T <sub>max</sub>	120 °C	Operating temperature max.