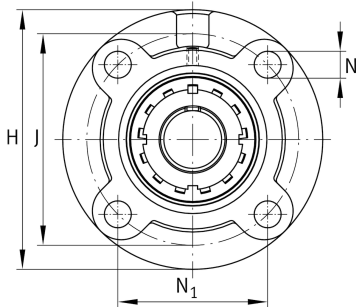

**FAG****UKFC210**

Flanged housing unit

Flanged housing unit UKFC

Technical information

**Your current product variant**

Material	GG	Grey cast iron
----------	----	----------------

Main Dimensions & Performance Data

d	45 mm	Bore diameter
H	165 mm	Height flange
U	40,2 mm	Total height unit
C _r	37.500 N	Basic dynamic load rating, radial
C _{0r}	23.200 N	Basic static load rating, radial
C _{ur}	1.210 N	Fatigue load limit, radial
≈m	3,15 kg	Weight

Mounting dimensions

J	138 mm	Pitch circle diameter (holes)
N	16 mm	Fixing bore
N ₁	97,6 mm	Distance fixing bore
T ₁	12 mm	Height spigot
Z	110 mm	Diameter spigot
	h8	Diameter spigot clearance
n	4	Number of screwing holes



Dimensions

A	28 mm	Height housing
A ₁	14 mm	Thickness of flange
A ₂	10 mm	Distance raceway
B	34 mm	Width
B ₁	55 mm	Locking collar total width
d ₃	70 mm	Outside diameter eccentric locking collar

Additional information

1	Number of housings
FC210	Housing
UK210	Bearing designation

Temperature range

T _{min}	-20 °C	Operating temperature min.
T _{max}	120 °C	Operating temperature max.