

**FAG****UKFC212**

Flanged housing unit

Flanged housing unit UKFC

Technical information



Your current product variant

Material	GG	Grey cast iron
----------	----	----------------

Main Dimensions & Performance Data

d	55 mm	Bore diameter
H	195 mm	Height flange
U	51,2 mm	Total height unit
C _r	56.000 N	Basic dynamic load rating, radial
C _{0r}	36.000 N	Basic static load rating, radial
C _{ur}	1.870 N	Fatigue load limit, radial
≈m	4,96 kg	Weight

Mounting dimensions

J	160 mm	Pitch circle diameter (holes)
N	19 mm	Fixing bore
N ₁	113,1 mm	Distance fixing bore
T ₁	12 mm	Height spigot
Z	135 mm	Diameter spigot
	h8	Diameter spigot clearance
n	4	Number of screwing holes

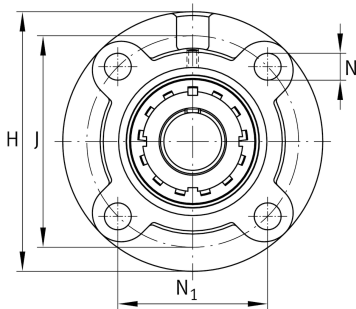



Dimensions

A	36 mm	Height housing
A ₁	15 mm	Thickness of flange
A ₂	17 mm	Distance raceway
B	40 mm	Width
B ₁	62 mm	Locking collar total width
d ₃	80 mm	Outside diameter eccentric locking collar

Additional information

1	Number of housings
FC212	Housing
UK212	Bearing designation

Temperature range

T _{min}	-20 °C	Operating temperature min.
T _{max}	120 °C	Operating temperature max.