

**PHEY45-XL**

## Take-up housing unit

Take-up housing units PHEY, cast iron housing, radial insert ball bearing with grub screws in inner ring, P seals

X-life

## Technical information

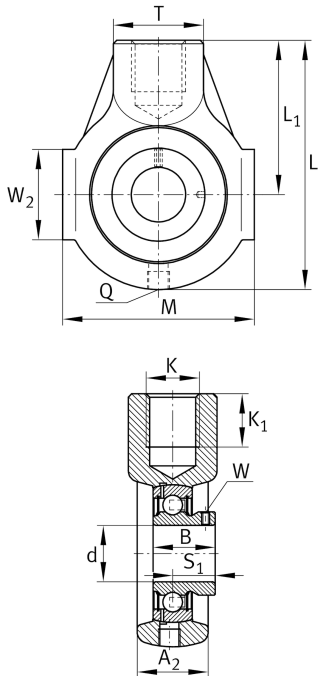

## Your current product variant

Material	GG	Grey cast iron
----------	----	----------------

## Main Dimensions &amp; Performance Data

d	45 mm	Bore diameter
L	145 mm	Length total
M	110 mm	Housing total width
A <sub>2</sub>	40 mm	Width housing
m	1,9 kg	Weight

## Mounting dimensions

K	M24	Thread fixing bore
K <sub>1</sub>	24 mm	Thread depth

## Dimensions

L <sub>1</sub>	90 mm	Distance shaft axis
T	40 mm	Height housing fixing side
W <sub>2</sub>	45 mm	Length of guidance face
Q	M6	Connection thread for lubrication



### Additional information

HE09	Housing
GAY45-XL-NPP-B	Bearing designation

### Temperature range

T <sub>min</sub>	-20 °C	Operating temperature min.
T <sub>max</sub>	120 °C	Operating temperature max.