

**RHE35-XL**

Take-up housing unit

Take-up housing units RHE, cast iron housing, radial insert ball bearing with eccentric locking collar, R seals

X-life

Technical information

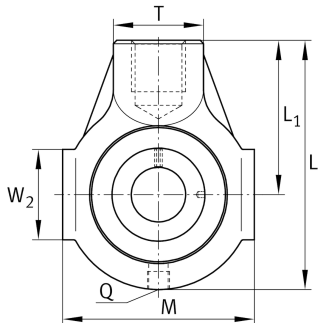
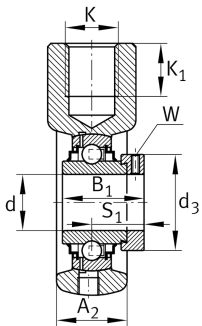

Your current product variant

Material	GG	Grey cast iron
----------	----	----------------

Main Dimensions & Performance Data

d	35 mm	Bore diameter
L	122 mm	Length total
M	90 mm	Housing total width
A ₂	32 mm	Width housing
≈m	1,38 kg	Weight

Mounting dimensions

K	M24	Thread fixing bore
K ₁	24 mm	Thread depth

Dimensions

L ₁	76 mm	Distance shaft axis
T	40 mm	Height housing fixing side
W ₂	49 mm	Length of guidance face
Q	M6	Connection thread for lubrication



Additional information

HE07	Housing
GE35-XL-KRR-B	Bearing designation

Temperature range

T _{min}	-20 °C	Operating temperature min.
T _{max}	120 °C	Operating temperature max.