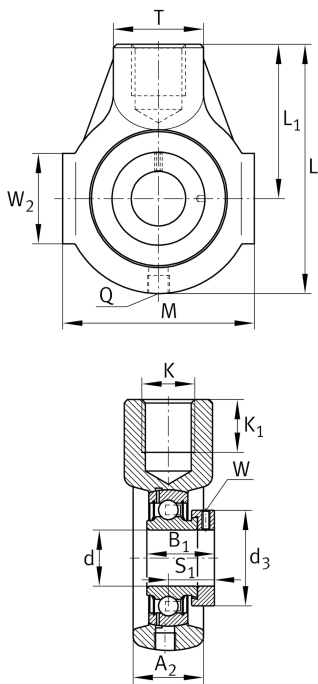

**PHE35-TV-FA125.5** [↗](#)

Take-up housing unit

Take-up housing unit PHE..-TV, RIBB plastic

Technical information

**Your current product variant**

Special material	TV	Plastic housing
Material	TV	Plastic
Manufacturing instruction	FA125.5	Bearing with Corrotect coating

Main Dimensions & Performance Data

d	35 mm	Bore diameter
L	125 mm	Length
M	90 mm	Housing total width
≈m	0,79 kg	Weight

Mounting dimensions

L ₁	76 mm	Distance shaft axis
L ₃	63 mm	Length guidance grooves
K	M16	Thread fixing bore
Q	1/4-28 UNF	Connection thread for lubrication

Dimensions

T	40 mm	Height (housing, mounting side)
A ₂	34,5 mm	Width housing



Additional information

HE07-TV	Housing
GRAE35-NPP-B-FA107/125.5	Bearing designation
KASK07-S-G	End cap
KASK07-S-R-NBR	Open protecting cap

Temperature range

T _{min}	-35 °C	Operating temperature min.
T _{max}	100 °C	Operating temperature max.