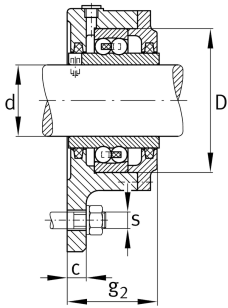
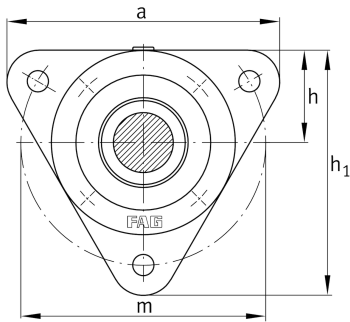

**FAG****F11204** [↗](#)

Flanged housing

Flanged housing for self-aligning ball bearing 112 with wide inner-ring, felt seal, grease lubrication

Technical information

**Main Dimensions & Performance Data**

d	20 mm	Shaft diameter
a	105 mm	Flange width
g ₂	42 mm	Total width with cover
h ₁	92 mm	Height flange
≈m	0,702 kg	Weight

Dimensions

	M10x1	Connection thread for lubrication
c	10 mm	Thickness of flange
D	47 mm	Outside diameter bearing
h	35 mm	Distance shaft axis
m	90 mm	Pitch circle diameter fixing holes
s	M10	Size of fixing screws

Temperature range

T _{min}	-20 °C	Operating temperature min.
T _{max}	100 °C	Operating temperature max.