



SD16X22X3

Radial rotary shaft seal

Double lip sealing ring SD



Technical information

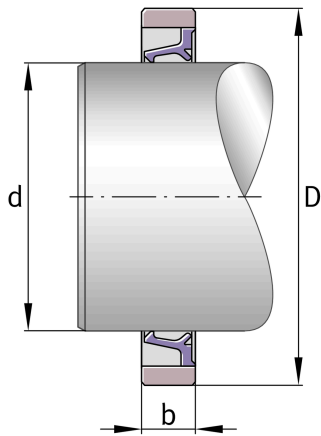

Main Dimensions & Performance Data

D	22 mm	Outside diameter
≈m	0,53 g	Weight

Main dimensions

B	3 mm	Width
---	------	-------