



SD22X30X4

Radial rotary shaft seal

Double lip sealing ring SD



Technical information

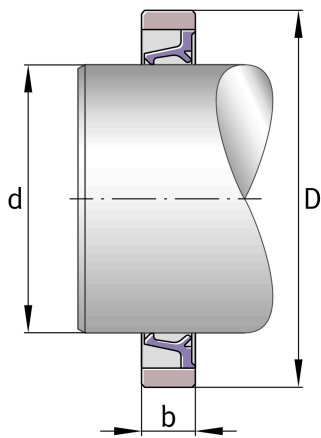

Main Dimensions & Performance Data

D	30 mm	Outside diameter
≈m	1,19 g	Weight

Main dimensions

B	4 mm	Width
---	------	-------