



SD50X62X5

Radial rotary shaft seal

Double lip sealing ring SD



Technical information

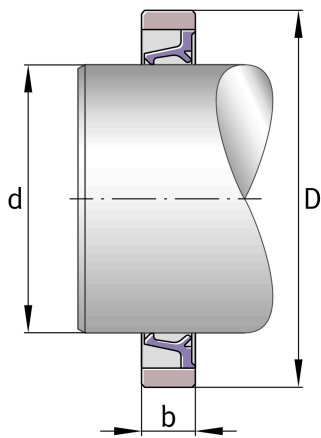

Main Dimensions & Performance Data

D	62 mm	Outside diameter
≈m	5,26 g	Weight

Main dimensions

B	5 mm	Width
---	------	-------