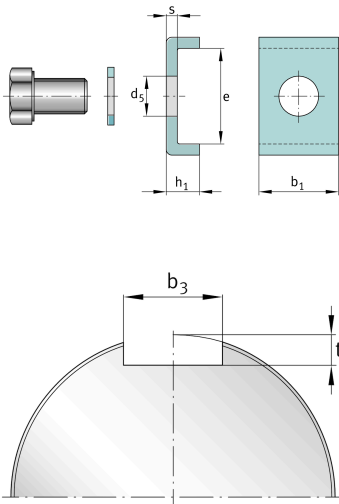

**FAG****MS3064**

Securing plate

Securing plate MS, locknut, DIN5406

Technical information

**Main Dimensions & Performance Data**

b ₁	24 mm	Length retaining ring
e	21 mm	Width inner retaining ring
h ₁	15 mm	Hight retaining ring
≈m	57 g	Weight

Mounting dimensions

b ₃	26 mm	Width retaining slot
t	10 mm	Hight retaining slot

Dimensions

s	5 mm	Thickness
d ₅	9 mm	Diameter fixing hole spacing

Additional information

M8x16	Hexagonal bolt
25 Nm	Mounting torque screw