

RUS26086-KS

Linear recirculating roller bearing unit

Linear roller bearings with spacer elements, with end face lubrication connectors RUS..

Technical information

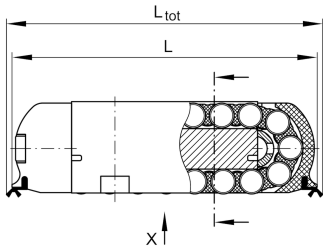
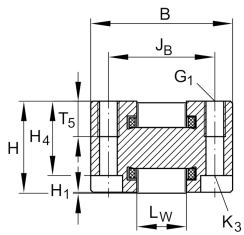

Your current product variant

Suffix	KS	With end face lubrication connectors
Size Code	26086	

Main Dimensions & Performance Data

L _{tot}	98 mm	Total length
B	40 mm	Width
H	26 mm	Height
C	76.000 N	Basic dynamic load rating
C ₀	113.000 N	Basic static load rating
≈m	0,525 kg	Weight

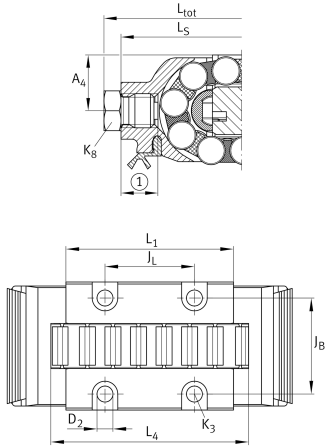

Mounting dimensions

L ₁	52,8 mm	Mounting dimension
J _B	30 mm	Mounting dimension
Tol J _B	± 0,1 mm	Tolerance
J _L	28 mm	
Tol J _L	± 0,1 mm	Tolerance
H ₁	0,2 mm	
L ₄	63 mm	Minimum support length
L _W	14 mm	
H ₄	21 mm	
T ₅	10,2 mm	
G ₁	M6	Fixing screws top (DIN ISO 4762-12.9)
G1 M _A	17 Nm	Tightening torque fixing screws
K ₃	M4	Fixing screws below (DIN ISO 4762-12.9)
K3 M _A max	5 Nm	Tightening torque fixing screws
D ₂	4,9 mm	
L _S	92 mm	
A ₄	13,5 mm	
	M6	Lubrication connection DIN3405-A
	6 mm	

Related products

VUS26086-A	Adjustment gib
UG9741, UGN9741-A, UZ9741, UZN9741-A, UFK4710, UFB6412	Suitable Guide rail